

## UZ Paint Pal Heavy Duty Paint Markers



- **Ideal for marking and color coding individual parts, assemblies, tags, cabinets, storage racks, machinery, dies, etc.**
- **Indelible, waterproof marker**- Will not fade or smear indoors or outdoors. Will mark on most surfaces, including oily, greasy and rusty metals, glass, plastic, wood and cardboard. Non-skip, fast drying.
- **Liquid ink 1/2 oz. (14 grams)**- will provide miles of dependable marks. Valve action tip prevents drying out - push down twice to prime for writing.
- **Heavy duty replaceable bullet shaped tip**. When the old tip is worn out, just replace it. For bolder marks reverse it. Standard bullet tip produces a bold, easy to read 1/8" wide line.
- **Reliable aluminum value**. Allows user to re-ink even when cap is left off. How many times have you thrown out a marker because of this? Internal agitator ball to fully mix paint.



PART #	COLOR	QTY.
104176	White	6
104177	Yellow	6
104178	Black	6
104179	Red	6
104792	Assorted	12 (3 of each color)

### Also Available

105131	Tan	6
105132	Gray	6
105133	Green	6

Available in  
an Assortment



PART # 00499

PART # 00491KP

Found on Page 1101

# Tapes

## Interlock - 38 High-Performance Tape Fastener



		PART #	QTY
• Secure	• Mount	<b>103485</b>	1
• Hold	• Repair	<b>103485-3</b>	3
• Attach			



Get the convenience and speed of a tape fastener with the holding power of a mechanical fastener.

1" x 10' Roll

### FEATURES:

- 38 PSI push-pull holding strength (262 kPa).
- Interlocking mushroom-shaped heads.
- High push-pull holding strength.
- Self engaging.
- High performance adhesive.
- Semi-permanent.
- Durable.
- Convenient.
- Adheres at temperature extremes.
- Interlock - 38 can replace hook and loop.

### BENEFITS:

- Holding power and reliability of mechanical fasteners such as bolts, screws, snaps, hooks, latches, etc.
- Fast assembly.
- 38 PSI (262 kPa).
- Only one product to inventory.
- Superior bonding strength to numerous surfaces.
- 2-1/2 times stronger than the holding power of the product.
- Provides the convenience of conventional hook & loop Fasteners - Reclosable.
- Resistant to sun and Ultraviolet Rays.
- Resistant to solvents and aging.
- Holds underwater.
- No tools required for installation.
- No need to drill holes.
- -20° F to 158° F (-29° C to 70° C) continuous.
- -20° F to 200° F (-29° C to 93° C) intermittent.

### HOLDING STRENGTH ADVANTAGE:

Interlock - 38	38 PSI (262 kPa)	5 times stronger
Hook & Loop	7 PSI (55 kPa)	Average Strength

### APPLICATIONS:

#### Automobiles, Truck, RV's

- Adhere access panels to consoles.
- Secure First-Aid kits, remove storage (tool boxes).
- Mount garage door openers.
- Affix headlight covers and window louvers.
- Mount electronic transponders for toll gates.

#### Electrical/Electronic

- Affix control panels, battery packs.
- Attach components.
- Secure testing devices.

#### Marine

- Attach boat covers.
- Secure removable tackle boxes.
- Lock down accessories and equipment.

#### Miscellaneous

- Mount signs or displays.
- Fasten covers equipment, machinery or vehicles.
- Use in clean rooms or where disinfecting is necessary.

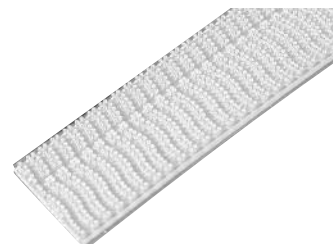

**Interlok-38 has a high-performance adhesive backing that can bond to many surfaces including but not limited to the following:**

- Bare Metals
- Painted Metals
- Fiberglass
- Structural Composites
- Glass
- Seal Wood
- Plastics
- ABS
- Acrylic
- Polystyrene
- Rigid Vinyl
- Polycarbonate
- Naugahyde
- Plasticized Vinyl

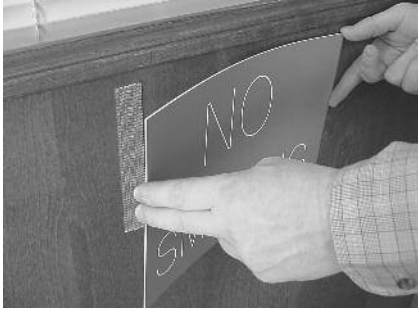



**DIRECTIONS - For Best Results**

1. Apply at or above 65°F (20°C).
2. Clean both surfaces with alcohol wipe or similar cleaner, removing all wax or grease.
3. Allow surfaces to dry completely.
4. Cut to length needed.
5. Peel off the protective liner (keeping fingers off of adhesive) and press firmly into place for full contact.
6. An immediate stick occurs. However allow 48-72 hours to reach maximum adhesive bond.
7. On porous surfaces such as unsealed wood, use staples or contact cement to fully attach.
8. Press tapes together to close; peel or pull to open. The audible “snap” indicates that the mushrooms are closed. Locate and attach the mushroom to mushroom tapes onto surfaces so that they are put in a push-pull (tensile) mode.

**IMPORTANT:**

- Store in a cool dry place. Shelf life 1 YR.
- Not recommended for powder paint, polyethylene or polypropylene surfaces.
- Adhesive backing may damage some painted, wall-papered, and/or brick surfaces.
- Reduce potential edge peel by rounding corners or recessing.
- TO REMOVE adhesive try using isopropyl (rubbing alcohol).

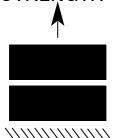
FIRST AID: Non-radiopaque (will NOT show up on X-RAY) and non-poisonous.

AVERAGE CLOSURE STRENGTHS	TENSILE STRENGTH 	SHEAR STRENGTH 	PEEL STRENGTH 
<b>Interlok-38</b>	<b>38 PSI</b>	<b>15 PSI</b>	<b>2 PIW</b>
<b>Hook &amp; Loop</b>	<b>7 PSI</b>	<b>9.5 PSI</b>	<b>1 PIW</b>

**SHOP SUPPLIES**

# Tapes

## UZ Ultra Tape

### Most pressure sensitive foam tapes fail - BECAUSE they...

- Have "Open" cells that absorb water and are subject to freeze and thaw damage!
- Are not resistant to occasional contact with solvent or gasoline!
- May not provide sufficient adhesion to the surface they bond!
- Are limited to interior use only!
- Fail when slammed or shocked by any impact!



### The answer to these and many other problems is...Ultra-Tape

A double sided closed cell urethane foam adhesive tape - that has a wide variety of applications on smooth clean surfaces with excellent RESULTS!!!! ULTRA-TAPE provides long-term durability indoors or outdoors. Its tough urethane foam and aggressive high strength adhesive will stand-up for years to wide temperature variations even when exposed to salt, gasoline or solvents.

- **Low water absorption - Interior/exterior use**- not affected by freeze or thaw cycles.
- **UV Resistant** - Exposure to sunlight will not deteriorate ULTRA-TAPE.
- **Solvent & Gasoline Resistant** - No adhesive failure in areas where solvent/gasoline may come in contact with the tape.
- **High Bond Strength** - Assures adhesion to all clean smooth surfaces. Bond strength up to 157 PSI.
- **Adheres to steel, plastic and wood** - Versatile can be used for many different applications.
- **Impact Resistant** - Withstands slam shock in temperature range of -20°F to +220°F. Rugged and dependable.
- **Easy To Use** - Clean the surfaces, apply to one side, remove the orange liner, press in place.
- **Repositionable** - Reduces errors and allows for correct alignment of the parts being bonded.

### UZ Ultra-Tape is the answer for hundreds of applications!!!!

- Signs
- Emblems
- Name Plates
- Fixtures
- Rub strips
- Side Moldings
- Carpeting
- Ground Effects
- Air Dam
- Luggage Racks
- Interior door panels
- Halo molding
- Electric Wires
- Weatherstrip
- Corner Protectors

### Ultra-Tape eliminates costly comebacks caused by poor adhesion of tapes to High Solids painted surfaces.

TEST DATA:

**Peel Strength:**

Bare Steel	15.0 PLI	Aluminum	144 PSI
OEM automotive paint	12.5 PLI	Wood	40 PSI
Clear automotive paint	12.0 PLI	Steel	157 PSI

Gasoline resistance:  
Passes

Water Absorption:  
(24 hour immersion) <1%

PART #	SIZE	QTY
91861	1/2" x 35'	1
91861-3	1/2" x 35'	3
91862	5/8" x 35'	1
91862-3	5/8" x 35'	3
91863	3/4" x 35'	1
91863-3	3/4" x 35'	3

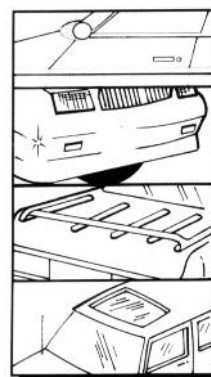
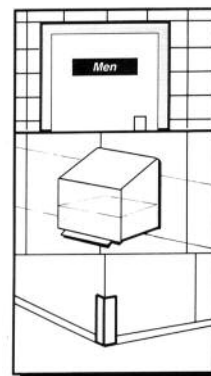

1 800 458-4018 www.uzengprod.com

## All Weather Electrical Tape

The premium electrical tape - Designed especially for maintenance use, the finest all-around tape available. No maintenance department can afford to be out of all weather tape.

- U.L. listed.
- Flame retardant for greater safety.
- Water resistant for longer lasting splices.
- High dielectric strength (10,000 Volts Avg.).
- Individually wrapped rolls.
- Temperature range of 0° F to +176° F.
- Equally effective in hot, cold, wet or dry applications.
- 7 Mils thick for strength without bulk.
- Excellent resistance to abrasion and acids.
- High "Creepback" rate for tighter splices.
- Govt. Spec. Mil-1-7798A.
- 3/4" x 66' rolls.

PART #	QUANTITY
200361	10 rolls



## Standard Electrical Tape

- UL listed.
- Weather resistant.
- Flame retardant.
- Dielectric strength 9,000 volts.
- 7 Mil. vinyl.
- Temperature range 0° F to +176° F.

PART #	DESCRIPTION	QUANTITY
10208	3/4" x 66'	1
P90996	3/4" x 30'	12
P90336	3/4" x 66'	10



## Amalgamating Wrap

Cold Shrink Tape to Insulate, Protect and Repair...

PART #	DESCRIPTION
10870	1 roll black 1"W x 30'L x .020"
10870-6	6 rolls black
91860	1 roll white 1"W x 10'L x .020"
91860-12	12 rolls white
103087	Multi-pack 2 ea #10870, 3 ea #91860 (60 ft black/30 ft white)



Amalgamating Wrap is a unique, self-sealing, flexible weather resistant, rubber wrap that has thousands of electrical and mechanical applications indoors and outdoors! Amalgamating Wrap requires no heat or open flames so there is no need for special equipment during application.

Amalgamating Wrap outperforms traditional wraps and solves many common problems that maintenance professionals face.

# Tapes

## High Density Teflon Thread Sealant Tape Premium Grade - 100% Pure

- Made in the U.S.A.
- Thickness: .0035".
- Density: 1.20 - 1.50.
- Meets: MIL-T-27730A.
- NSF recognized.
- Surest seal with less wraps
- Seals stainless steel, coarse threads, gas lines.
- Will not freeze or harden.



PART #	ROLL SIZE	QUANTITY
200360	1/2" X 520"	1

## Standard Teflon Thread Seal Commercial Grade - 100% Pure.

- Thickness: .0032.
- Density: Medium
- Meets Mil-T-27730A.
- Eliminates high torque force.



PART #	ROLL SIZE	QUANTITY
10350	1/2" x 520"	1
10350-5	1/2" x 520"	5
10351	1" x 520"	1
P53906	1/2" x 260"	1

## Duct Tape - Industrial Grade

- Polyethylene coated cloth.
- Good tensile and handling characteristics.
- For HVAC and other repairs.



PART #	ROLL SIZE	QUANTITY
10211	Grey 2" x 60 yds.	1
10212	Grey 4" x 60 yds.	1
P90983	Black 2" x 60 yds.	1

## Colored Duct Tape

- Colored fabric, polyethylene coated.
- Use for color coding.
- Use for repairs to canvas, vinyl seats and armrests.
- Ideal for general maintenance.
- Waterproof.
- 2" x 20 yard roll size.

PART #	COLOR	QUANTITY
10974	Red	1
10975	Blue	1
10976	Green	1
10977	Brown	1
10978	Olive drab	1
10979	Black	1



## Cloth Carpet Tape

- Adhesive on both sides.
- Extra strong for durability.
- Strips in one piece.
- For indoor and outdoor use.

PART #	ROLL SIZE	QUANTITY
10980	1-1/2" x 42'	1
10981	2" x 75'	1



## Masking Tape General Purpose

- For masking areas before painting (not recommended for heat applied painting).

PART #	ROLL SIZE	QUANTITY
10206	3/4" x 60 yds.	1
10207	1" x 60 yds.	1



## Masking Tape Auto Grade

- Premium quality.
- Strips off without residue.
- For Automotive refinishing and general use.

PART #	ROLL SIZE	QUANTITY
10877	3/4" x 60 yds.	1
10879	1" x 60 yds.	1
10880	2" x 60 yds.	1



# Tapes

## Strapping Tape-Industrial Grade

- Fiberglass reinforced.
- Rubber base adhesive.
- Tensile: 180 lbs/inch.

PART #	ROLL SIZE	QUANTITY
10209	3/4" x 60 yds.	1
10210	1" x 60 yds.	1



## Polypropylene Carton Sealing Tape

- Non- yellowing.
- Strong acrylic adhesive.
- 2" x 55 yd. Rolls.
- Available in clear or tan.

PART #	COLOR	QUANTITY
10213	Tan	1
10214	Clear	1



## Tape Dispenser

- One hand operation.
- Ideal for carton sealing tape No.# 10213 and 10214.

PART #	QUANTITY
90421	1



## OSHA Striping Tape

- A must for all industrial plants.
- Designated areas for specific functions.
- Weather and chemical resistant.
- PVC film with rubber base adhesive.

PART #	COLOR	ROLL SIZE	QUANTITY
10215	Yellow/Black	2" x 36 yds.	1



## Make Large Size Clamps Instantly & Economically with Make-A-Clamp

MAKE-A-CLAMP makes every size clamp a plant needs, from 2" diameter on up, on the spot. It's a key addition to a conventional clamp inventory.

### Make-A-Clamp makes sense in every tool crib

Use It Wherever You Need Clamping Around, In, or Out of the Plant.

- Use for temporary or permanent repairs for securing, mounting, strapping, clamping, and positioning.
- Hang, strap, or secure anything to poles, beams, pipes, etc.
- Hold or clamp units together during welding or assembly.
- Use for all conventional clamping jobs.



Minimize "down" time, repair time and your hose clamp inventory in sizes, dollars, and shelf space. Make-A-Clamp gives you total maintenance clamp system in a kit, consisting of a continuous roll of stainless steel banding (which you cut to the size diameter you need) and adjustable worm gear assembly fasteners.

#### APPLICATIONS:

- Connect ductwork.
- Connect hoses.
- Clamp steel die frames together.
- Put holding patch on drain pipes.
- Hold pipe insulation.
- Hold a rubber boot.
- Install vent tubing.
- Secure thermostat enclosures.
- Field installation of equipment.
- Attach heat-trace cable to pipes.
- Secure wire cloth on face of drum.
- Connect spouts to flexible connectors.

PART #	QUANTITY	DESCRIPTION
220730	1	SHOP KIT- CONTAINS 50 FT. OF BANDING, 10 FASTENERS
220731	10	10 EA. FASTENERS ONLY
220732	1	100 FT. OF BANDING ONLY

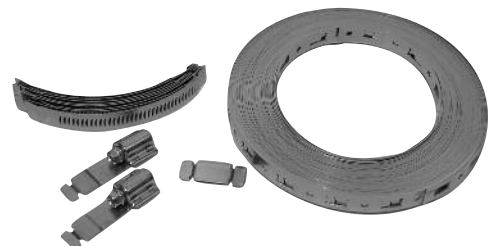

To determine lengths of make-A-Clamp band material, multiply diameter in inches x (3.146), minus 4.5" for the adjustable fastener end, or determine circumference by measurement, less 4.5" for adjustable fastener end.

$$(\text{Diameter} \times 3.146) - 4.5 = \text{Band Length Required}$$

### Band Length Table

- (Allows for insertion of Fasteners)
- Band should always be cut midway on small round hole for smooth fastener-fit.
- This table is accurate for the diameters indicated.

DIA.	LENGTH TO CUT ON MARK	DIA.	LENGTH TO CUT ON MARK	DIA.	LENGTH TO CUT ON MARK	DIA.	LENGTH TO CUT ON MARK
2"	2-1/2"	9"	24-1/8"	16"	46-7/8"	26"	77-1/4"
3"	5-1/16"	10"	27-7/8"	17"	49-7/16"	28"	83-5/8"
4"	8-7/8"	11"	30-3/8"	18"	53-1/8"	30"	89-7/8"
5"	11-7/16"	12"	34-3/16"	19"	55-3/4"	32"	96-3/8"
6"	15-3/16"	13"	36-3/4"	20"	59-1/2"	34"	102-5/8"
7"	17-3/4"	14"	40-1/2"	22"	65-7/8"	36"	108-7/8"
8"	21-1/2"	15"	43-1/16"	24"	72-1/8"	38"	115-1/4"

(All these sizes and more - over 1000 different SAE worm-drive clamp sizes - can be made from a Make-A-Clamp Shop Kit)

# Strapping

## Rope Ratchet The Perfect Tie-Down

**Rope Ratchet** is a unique, compact ratchet system that secures a wide variety of items quickly and easily. It solves many of the problems associated with standard tie-down methods: Time consuming; Hard to do knots; Elastic cords that stretch.

**Rope Ratchet** is fast, easy-to-use and will not stretch.

- **Time-Saving** - Just hook ratchet and cord hook in place and pull free end of cord. Ratchet automatically locks cord in place so it will not slip back. To loosen just press the release lever.
- **Easy-to-use** - No complicated knots to tie, or un-tie.
- **Effective-Rope Ratchet** will secure items as tightly as required. No more shifting or slipping during transporting.
- **Built Tough** - Made of tough, weather resistant nylon for years of hard use. Unaffected by weather.
- **Versatile** - Can be used to secure items for hoisting, packing, covering and transporting.
- **Compatible- Rope Ratchet** may be used with any rope or cord of required diameter.
- **Unlimited Uses- Rope Ratchet** holds boxes, crates, tarps, pallets, tent lines, and assorted cargo items. For use with bike, motorcycles, RV's, ATV's, cars, vans, trucks, busses, boats, planes, trains and more. ROPE RATCHET can be used anywhere the job calls for a secure tie-down.



PART #	TYPE	DIA	ROPE LENGTH	WT. CAPACITY	BODY SIZE
55009	Mini rope ratchet	1/8"	6 Ft.	75 Lb.	1-3/8" X 3/4"
91647	Standard	1/4"	10 Ft.	150 Lb.	2-1/4" X 1-1/4"
91842	Hefty	3/8"	10 Ft.	250 Lb.	3-1/2" X 2"
113876	Hang'Em High Hoist	3/8"	20 Ft.	250 Lb.	-

### Rope Ratchet Combo #113883

- Includes: 1 each Mini rope ratchet (55009)  
 1 each Standard rope ratchet (91647)  
 1 each Hang'Em High Hoist (113876)

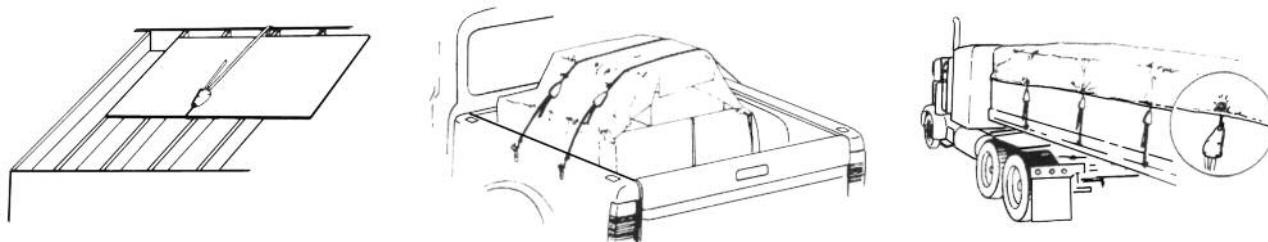

## Polyethylene Grommet Rolls

- Ideal for all shapes and sizes of holes.
- Use with any panel material.
- Effective with sheet metal, wood, aluminum, plexiglass, and glass.
- Cuts easily.
- Fits securely without adhesives.
- 176° F maximum operating temperature.
- In 20-1/2" rolls.

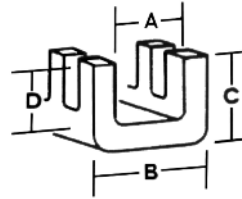

PART #	RANGE OF THICKNESS / IN.(MM)	A CHANNEL WIDTH	B WIDTH	C HEIGHT	QUANTITY
10881	.016-.051" (.41-1.30)	.055 (1.40)	.150 (38.10)	.157 (4.00)	1
10882	.051-.083" (1.30-2.11)	.091 (2.31)	.177 (4.50)	.157 (4.00)	1
10883	.083-.130" (2.11-3.30)	.130 (3.30)	.220 (5.59)	.157 (4.00)	1
10884	.130-189" (3.30-4.80)	.197 (5.00)	.327 (8.31)	.228 (5.79)	1
10885	.189-256" (4.80-6.50)	.260 (6.60)	.386 (9.80)	.240 (6.10)	1
10886	.256-.319" (6.50-8.10)	.319 (8.10)	.445 (11.30)	.256 (6.50)	1



## Perforated Strapping

- 3/4" Wide
- 1/4" Holes
- 1/2" Centers

PART #	FT. PER ROLL	QUANTITY
10892	10	1
10893	100	1



## Mechanics Wire

- Spooled
- Annealed
- Soft

PART #	GAUGE	LBS.	FT. PER ROLL	QUANTITY
80300	14	5	295	1
80301UZ	16	5	480	1
80302UZ	18	5	830	1
80303UZ	16	2	190	1
80304UZ	18	2	332	1



# Shop Cloths

## UZ Industrial Shop Cloths

All-purpose wiping cloths designed to work for you!  
More versatile than cloth rags, yet stronger and more durable than paper.

## Disposable Wiping Cloths

- Economical alternative to rental towels
- Nylon-scrim reinforced
- Can be rinsed and reused
- Absorbs more than four times its weight in water

PART #	SIZE	QTY.
67350	9.75" x 17"	6 boxes of 150 (900 wipes per case)

## Shop Towels

- Resists abrasion and solvents
- Highly absorbent in water, oil or solvents
- Contain no binders or glue
- Low-linting

PART #	SIZE	QTY.
67367	12" x 12"	450

## Food Service Wipes

Ideal Wipes for Food Service Applications

- Quality stitch-bonded scrubbing towels
- Strong, dependable, and even reusable
- Wipes provide cloth-like feel and performance
- Perfect wet wipers for counter and table cleaning

PART #	SIZE	QTY.
104696	14" x 20"	150

## Cotton Wiping Clothes

Convenient, Highly-Absorbent and Economical

- Convenient pop-up dispenser provides towels when you need them
- Contains about 100 rags of super-absorbent cotton cloths
- Cloths are machine washable to use over and over again
- Can be used for an endless number of jobs

PART #	QTY.
67352	100



SHOP SUPPLIES

## Portable GFCI Products Ground Fault Circuit Interrupters

Products with GFCI, constantly monitor electricity flowing into a product; the GFCI will quickly shut off the current if the electricity flow differs even slightly.

- Designed to protect people against electric shock from an electrical system
- Use in a variety of electrical applications; ranging from Construction, Industrial and Institutional to Personal use
- Automatic reset feature provides extra protection for the user
- Use in both indoor and outdoor environments

All products have yellow SJTW cord.

### Shock Safe® Power Center GFCI (Ground Fault Circuit Interrupt) Temperature Range: -40°C to 60°C (-40°F to 140°F)

UL Listed. OSHA accepted for outdoor extension cord use. 125VAC, 15A, 1800W, 60HZ, Rainproof, Class "A". Provides protection from potentially dangerous ground fault current leakage. Lighted triple tap end to show power is on.



PART #	CORD LENGTH	WIRE SIZE	INSULATION TYPE	CORD COLOR	RATING
101910	2'	12/3	SJTW-A	Yellow	15 AMP

### 3-Wire Single Outlet GFCI Adapter Plug Indoor Use Only

UL, ULC, 120V/15A  
NEMA 5-15 P&R

Part #

107467

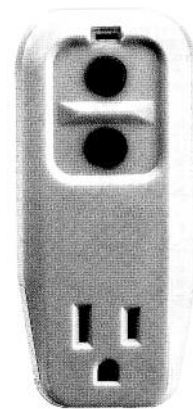

### In-Line GFCI Cord Set

Convenient, safe all-in-one GFCI cord set

UL, ULC, 120V/15A

12/3 AWG SJTW Cord

PART #	CORD LENGTH
107468	18"
107469	25'



# GFCI Cords & Surge Protectors

## Triple Tap With GFCI Right Angle Plug Power "On" LED indicator

UL, ULC, 120V/15A  
NEMA 5-15P AND (3) 5-15 R  
12/3 AWG SJTW Cord

Part #	CORD LENGTH
107471	2'



## Triple Tap With In-Line GFCI

UL, ULC, 120V/15A  
NEMA 5-15 P and (3) 5-15 R  
12/3 AWG SJTW Cord

Part #	CORD LENGTH
107470	3'



## GFCI Quad Box with 4 NEMA 5-15 R GFCI Outlets Power "On" LED indicator

UL 120V/15A  
NEMA 5-15P Plug, 15A Circuit Breaker  
12/3 AWG SJTW Cord

Part #	CORD LENGTH
107473	6'

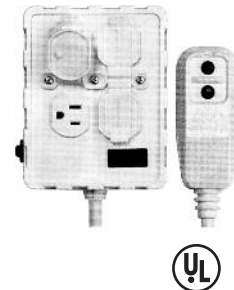

All products have yellow SJTW cord.

## 6-Way Multi-Outlet Strip with Surge Protector

- On/Off Switch.
- Built-in Hanging Brackets.

UL Listed. Provides 6 surge-protected NEMA-15R outlets for monitors, computers and other electronic-based equipment. Thermoplastic insulated cord with NEMA 5-15P plug.

PART #	CORD LENGTH	WIRE SIZE	INSULATION TYPE	CORD COLOR	RATING
101916	4-1/2'	14/3	SJT	Gray	15 AMP



## Arctic Blue™ All-Weather TPE-Rubber Extension Cords With Primelight™ Power Indicator Light and Primelok™ Connector

- Primelok™ connector keeps power tools connected
- Primelight™ power indicator light shows when power is on
- Superior flexibility - Resists stiffening or cracking under the most extreme weather conditions.  
Temperature range -58°F to +221°F (-50°C to +105°C).
- Water resistant - Will not absorb water that can corrode copper conductors or cause dangerous electrical shock.
- Flame retardant - Protects against accidental cord fire.
- Oil resistant - Jacket will not deteriorate when used where oil or petroleum products may be present.

PART #	DESCRIPTION	LENGTH	JACKET COLOR	QTY
123495	Locking Ext. Cord 14/3 SJEOW	25'	Blue/Orange	1
123496	Locking Ext. Cord 14/3 SJEOW	50'	Blue/Orange	1
123497	Locking Ext. Cord 14/3 SJEOW	100'	Blue/Orange	1
123498	Locking Ext. Cord 12/3 SJEOW	25'	Blue/Orange	1
123499	Locking Ext. Cord 12/3 SJEOW	50'	Blue/Orange	1
123500	Locking Ext. Cord 12/3 SJEOW	100'	Blue/Orange	1



## Heavy Duty Extension Cords With Primelight™ Power Indicator Light and Primelok™ Connector

- Primelok™ connector keeps power tools connected
- Primelight™ power indicator light shows when power is on
- Ultra flexible, flame retardant and water resistant SJTW cord
- Large, flexible, ribbed strain relief prevents separation of the cord jacket from plug
- Listed by UL and CSA to meet safety standards in the US and Canada. Exceeds OSHA requirements for indoor and outdoor use.
- Temperature range -40°F to +140°F, (-40°C to +60°C).

PART #	DESCRIPTION	LENGTH	JACKET COLOR	QTY
122753	Locking Ext. Cord 14/3 SJTW	25'	Yellow	1
122754	Locking Ext. Cord 14/3 SJTW	50'	Yellow	1
122755	Locking Ext. Cord 14/3 SJTW	100'	Yellow	1
122756	Locking Ext. Cord 12/3 SJTW	25'	Red/Blue	1
122757	Locking Ext. Cord 12/3 SJTW	50'	Red/Blue	1
122758	Locking Ext. Cord 12/3 SJTW	100'	Red/Blue	1



## Triple Receptacle Retractable Reel Extension Cord- with 10 AMP Circuit Breaker

PART #	CORD LENGTH	WIRE SIZE	INSULATION TYPE	CORD COLOR
101908	30'	16/3	SJT	Black

UL Listed. Thermoplastic cord insulation with Triple NEMA 5-15R molded receptacles. Steel reel enclosure with NEMA 5-15 molded plug. OSHA Acceptable.



## Indoor/Outdoor Rated - Single Tap Temperature Range: -40°F to 140°F (-40°C to 60°C)

PART #	CORD LENGTH	WIRE SIZE	INSULATION TYPE	CORD COLOR	RATING
101909	25'	16/3	SJTW	Yellow	13 AMP
101911	50'	16/3	SJTW	Yellow	13 AMP
101912	100'	16/3	SJTW	Yellow	10 AMP



## All Season All Weather with Lighted Plug Temperature Range: -58°F to 140°F (-50°C to 60°C) OSHA Acceptable

PART #	CORD LENGTH	WIRE SIZE	INSULATION TYPE	CORD COLOR	RATING
101913	50'	16/3	SJTW	Blue	13 AMP
101914	50'	12/3	SJTW	Blue	15 Amp



\* 101914 also has a locking plug connector

# Lighting

## Fluorescent Lights

### Work Lights Available with 6' and 25' Cord - Pro Series

UL Listed. Yellow polypropylene handle with grounded NEMA 5-15R receptacle and rocker switch. Long life (10,000 hours) 13 WATT, compact fluorescent lamp installed. Fold-away hook. Ballast in handle. High impact polycarbonate lamp protector with light reflector. Clear polycarbonate end cap for spot lighting. Thermoplastic, weather - resistant cord insulation with NEMA 5-15P plug.

PART #	CORD LENGTH	WIRE SIZE	INSULATION TYPE	CORD COLOR
101905	6'	16/3	SJTOW	Yellow
101906	25'	16/3	SJTOW	Yellow



### Work Light with 25' Cord - OSHA Requirement

UL/CUL Listed, meets OSHA requirements, no switch, no exposed metal, no receptacle. Polypropylene ballast enclosed near plug end of cord. Long life (10,000 hours) 13 WATT, compact fluorescent lamp installed. High impact clear butyrate lamp protector with light reflector. Oil resistant thermoplastic cord that remains flexible at low temperatures. NEMA 1-15P molded plug.

PART #	CORD LENGTH	WIRE SIZE	INSULATION TYPE	CORD COLOR
101907	25'	18/2	SJTOW	Yellow



### Replacement Bulb

13 WATT Long Life (10,000 Hours)

PART #	QUANTITY
272517	1



### Fluorescent Work Light with 50' Cord on Retractable Reel

UL Listed. Long life (10,000 hours), 13 WATT, compact fluorescent lamp installed. Fold away hook. High Impact polycarbonate lamp protector with light reflector. Clear polycarbonate end cap for spot lighting. Thermoplastic cord insulation and adjustable stop. Steel reel.

PART #	CORD LENGTH	WIRE SIZE	INSULATION TYPE	CORD COLOR
272520	50'	18/2	SVT	Yellow



### Clamp Light with 6' Cord with 8-1/2" Bell Shade

UL Listed. On/Off switch; sturdy aluminum reflector, ball joint for easy positioning. Spring steel clamp with vinyl scratch protector. Use 100 WATT incandescent bulb (not included).

PART #	CORD LENGTH	WIRE SIZE	INSULATION TYPE	CORD COLOR
101915	6'	18/2	SPT-2	White



## Work Light with 25' Cord

UL Listed. Yellow polypropylene handle with galvanized metal lamp shield. Thermoplastic cord insulation with NEMA 5-15P molded plug. Push on/push off switch. NEMA 5-15R receptacle. Use 75 WATT "rough service" incandescent bulb (not included). OSHA acceptable for general use.

PART #	CORD LENGTH	WIRE SIZE	INSULATION TYPE	CORD COLOR
101904	25'	16/3	SJT	Orange

P54123 Replacement Cage for 101904

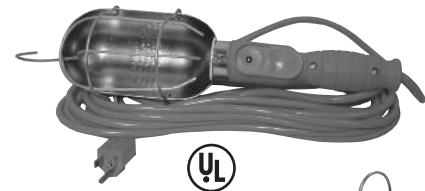

**Replacement  
Cage also  
available**



## MAGNALite PRO Cordless/Rechargeable 36 LED Work Lamp 7.2v - Lithium Battery

- Cordless/Rechargeable 7.2v Lithium (LI-ON) Battery
- 36 LED
- Magnetic base for position and light control
- 120 Degree Pivoting Range, Forward/Backward
- ABS Body for Better Grip
- Sleek Ergonomic Design
- Fully Recharges in 5 Hours
- Runs up to 6 Hours on a Single Charge
- Up to 1,000 Hours of Battery Life
- LED Lifetime Rated Up to 50,000 Hours
- 1,100 Lumens
- Operating Temp: <50 Degrees C
- UL Approved Charger

UZ PART #	DESCRIPTION	QTY
983484	CORDLESS/RECHARGEABLE 36 LED WORK LAMP	1
983493	7.2V LITHIUM BATT FOR MAGNALITE PRO	1



SHOP SUPPLIES

## Tuffskin Rough Service Bulbs

- 5000 Hour Average Rated Life.
- Silicone - Coated to Eliminate Thermal Shock.
- Excellent For Use in Food Processing and Health Care.
- Moisture Resistant and Machine Spatter.
- 130 V. Rated.

PART #	WATTS	BASE	LAMP	QUANTITY
90418	60	MED.	A-19	6
90418-24	60	MED.	A-19	24
90419	75	MED.	A-19	6
90419-24	75	MED.	A-19	24
90420	100	MED.	A-19	6
90420-24	100	MED.	A-19	24



Will not shatter when broken

## Rough Service Bulbs

- 9 Supports
- Short Stubby Stem
- Brass Base
- 130 V. Rated

PART #	WATTS	BASE	LAMP	QUANTITY
90415	50	MED.	A-19	6
90416	75	MED.	A-19	6
90417	100	MED.	A-19	6



# Lighting

## 12 Bulb LED Flashlight

The new UZ LED Flashlight is the flashlight of the future. The ultra-bright light emitting diode ( LED ) bulbs will not burn out like conventional krypton bulbs and helps batteries to last about 5 times longer than regular flashlights.

- 12 energy saving LED bulbs to provide ultra-bright light
- Weather-proof and shock-resistant, tough metal casing
- Push-button, sealed rubber switch and handy carrying strap
- 3 AAA batteries included
- Size: 4 5/8" long



PART#	DESCRIPTION
118491	PK1 12 BULB LED FLASHLIGHT W/UZ LOGO

## Ultra Bright 2W LED Flashlight 2 Watt, 100 Lumens

- EZ-focus provides a smooth spot to flood beam simply by twisting head of light
- Perfect beam - no black spots
- Run time: 5 hours
- DC/DC technology provides maximum light output throughout the life of the battery
- Push button on back of light (momentary or constant on/off feature)
- Aircraft grade aluminum
- Lanyard included
- Runs on 2 AA Alkaline batteries (included)
- Lifetime warranty



PART#	DESCRIPTION	QTY
121668	2AA 2W LED EZ-Focus Flashlight	1

## High-Performance LED Tactical Flashlight 3 Watt, 150 Lumens

- 3 modes: high, low, strobe
- Anodized aluminum
- Impact resistant
- Tactical clip
- Holster included
- Soft-touch mode change
- Compact and lightweight
- Water resistant
- Runs on 2CR123A Lithium batteries (included)
- Run time: 12 hours low; 3 hours high



PART#	DESCRIPTION	QTY
121669	3W Lithium Tactical Flashlight	1

## Roughneck Flex 360° LED Clamp Light

- High performance LED with 130 lumens
- Head rotates 180° and pivots 90°
- Custom optics for long range or flood use
- Strong and sturdy Clamp with a Non-slip grip
- Powerful magnetic back
- Runs on 3AA batteries (Included)

PART#	DESCRIPTION	QTY
123505	Flex 360 Flashlight	1



## Roughneck 200 Lumen 3AAA LED Flashlight

- High Performance XR-E LED
- 3 Modes: Low, High and Strobe
- 200 Lumens (high) 70 Lumens (low)
- Adjustable Spot to Flood Beam
- Beam Distance: 130 meters (415')
- Water Resistant
- Run Time: 2 hrs (high) 6 hrs (low) 8 hrs (strobe)
- 3AAA Alkaline Batteries Included
- Aircraft Grade Aluminum Body Withstands 5' Drop test
- Tactical Switch on End Cap

PART#	DESCRIPTION	QTY
40007	Roughneck 200 Lumen	1



## Xtreme™ 4W LED 3C Flashlight

- High-powered LED lasts for 100,000 hours
- Yields an amazing 4-Watt, 150 lumens
- Constructed of aircraft grade machined aluminum
- Water resistant
- Features a convenient lanyard and rubber grip
- Runs for 100 hours off 3 "C" batteries (118961)
- 10" in length
- Lifetime warranty

PART#	DESCRIPTION	QTY
119931	XTREME 4W LED 3C FLASHLIGHT	1



## Xtreme™ 1W LED Clip Flashlight

- Lightweight & Water Resistant
- 1-Watt Rebel 40 high-powered LED which produces a square beam, 55 lumens and lasts for 100,000 hours
- Polymer body that is impact, chemical, corrosion, and water resistant
- 3 colored lenses included: red-night vision, blue-tracking, green-map reading
- Handy holster w/ lens storage include and useful pocket clip
- Powered by 2 "AA" Rayovac Alkaline Batteries(118959) (included)
- DC-DC voltage boost up technology maintains maximum brightness over battery life.
- Runtime = 9 Hours
- 6" in length
- Lifetime warranty

PART#	DESCRIPTION	QUANTITY
119932	XTREME 1W LED CLIP FLASHLIGHT	1



## Xtreme™ 1W LED Headlight

- Lightweight & Water Resistant
- 1-Watt Luxeon LED up to 45 Lumens and lasts for 100,000 Hours
- 3 - 5mm LEDs: (2)red night vision and (1)blue tracking, w/rotating diffuser lens
- Powered by only 1 "AA" Rayovac Alkaline Battery(118959) (included)
- DC-DC voltage boost up technology maintains maximum brightness over battery life.
- Worn directly on head or over hard hat
- Runtime = 2 Hours
- Lifetime warranty

PART#	DESCRIPTION	QUANTITY
119933	XTREME 1W LED HEADLIGHT	1



# Lighting

## Industrial Flashlight with Magnet

- Color - yellow with black trim.
- An industrial quality flashlight built to pass the toughest test... a full day's work. This flashlight is packed full of the features you want most. The case is made of high impact polypropylene Won't crack or split, or let you down.
- PR-2 bulb.
- Uses 2 "D"-cell batteries (not included).



PART #	QUANTITY
10475	1

## Industrial Swivel Flashlight

- Durable rubber and polypropylene construction
- Environmentally friendly materials- nontoxic rubber
- Shatterproof - 7ft drop tested
- Oil, grease, chemical and water resistant
- Useful swiveling head - rotates 90 degrees
- 3 spot to flood settings let's you control your beam
- Supper bright Krypton bulb
- Rubber grip fits perfectly in hand
- Easy push button switch
- Sturdy metal belt clip



2 AA

2 D

PART#	TYPE	QUANTITY
119078	2AA	1
119079	2D	1
119080	2AA & 2D	1 COMBO PACK

## 1W Led Flashlight/Lantern Combo Light

Developed for peak performance in the harshest environments, the light features the latest in High-Performance LED technology. It offers unique features while delivering the quality and dependability expected from the Remington brand.

Features :

- Tactical switch on tailcap
- Head extends into a lantern
- Absolute latest in High-Performance LED technology with LED's that never need to be replaced.
- Constructed of aircraft grade machined aluminum
- Water resistant
- 1 Watt 60 Lumens
- Operates on 3 Alkaline AAA batteries (included)
- Nylon holster included



### 1. Lantern Option

The flashlight easily extends into a lantern with the ability to light an enclosed area.

### 2. Flashlight Option

The lantern easily converts into a flashlight for a focused beam.

### 3. Class II Anodized Aluminum

Light weight, impact and water resistant.

### 4. Spot to Flood

Lens allows for either projection or proximity lighting.

PART #	DESCRIPTION	QUANTITY
122985	1W Led Flashlight/Lantern Combo	1

## Alkaline Batteries - Rayovac Ultra Pro

- Designed for long life in industrial applications

PART#	TYPE	QUANTITY
118959	AA	8
118960	AAA	8
118961	C	6
118962	D	6
118963	9V	6



Available in  
an Assortment



Part #00580  
Found on page 1102  
Part #00580KP  
Found on page 1102

## Premium Alkaline Batteries

- Designed for long life in high-drain applications.
- Out-perform regular batteries by a wide margin.

PART #	TYPE	QUANTITY
10792	D-Cell	12
10793	C-Cell	12
10794	AA	24
10795	AAA	24
118488	AAAA	12
10796	9V	6
200801	6V	1



Available in  
an Assortment



PART # 00736  
Found on Page 1102  
PART # 00736KP  
Found on Page 1102

## Standard Batteries

- Industrial Quality.
- Carbon zinc

PART #	TYPE	QUANTITY
10798	7-1/2V	1
10799	6V Lantern	2



## Lithium Batteries

PART#	DESCRIPTION	QTY
121670	CR123A Lithium Batteries	2



## Lithium Batteries

- Coin style 3V

PART #	TYPE	QUANTITY
118489	#CR2016	5
118490	#CR2032	5



## Replacement Bulbs

PART #	BULB #	DESCRIPTION	QUANTITY
200454	PR-2	2 D-Cell, Flange Base	10
200455	K-2	2 D-Cell, Krypton	10
200456	PR-6	2 D-Cell, Indust. Bulb	10
200457	PR-13	6V Cell, Flange Base	10



# Measuring

## 26'/8M Magnetic Tape Measure

- Ergonomic rubber grip
- Non-slip rubber blade lock button
- Auto adjust end hooks, moves for accurate measurements
- Magnetic end features powerful dual magnets to assist in single person measuring



**PART #**  
116006

**QUANTITY**  
1

## UZ Gauges

### Pocket Calipers # 103325



### Standard Screw Gauge # D0016

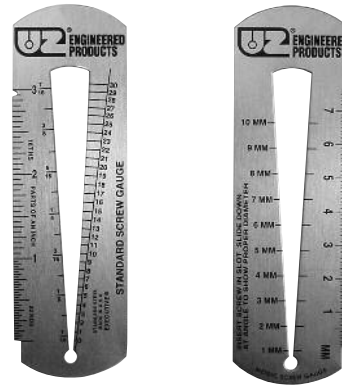

### Standard Thread Pitch Gauge # D0237



### Metric Thread Pitch Gauge # D0238



### Fractional Drill Gauge #100469

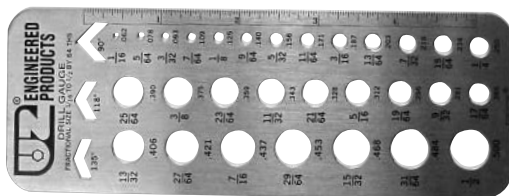

### Metric Drill Gauge # 100470

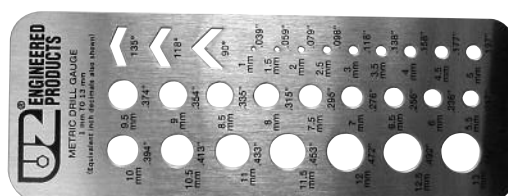

## Battery Terminal Gauge #D0068

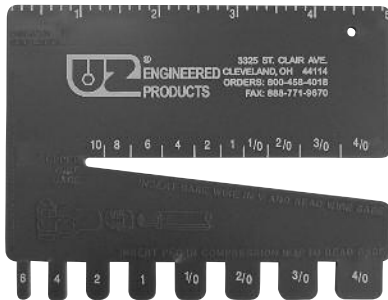

## Bolt & Screw Combo Gauge #D0020

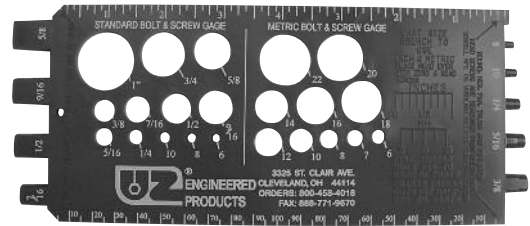

## Pipe, Tube, Fitting & Hose # 103326 Gauge # 103326

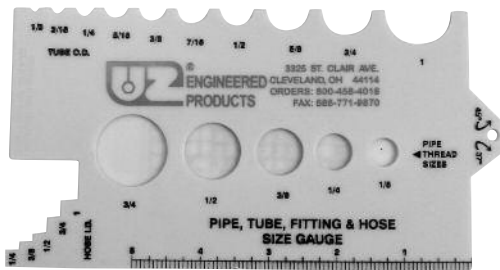

## Rivet Gauge # 103327

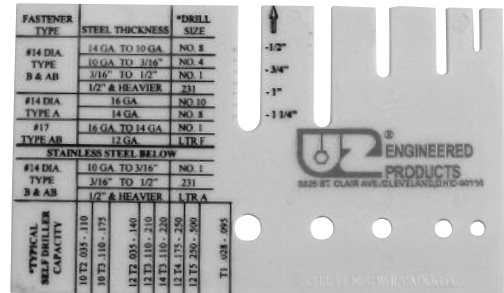

## Tube & Hose Gauge # 103328

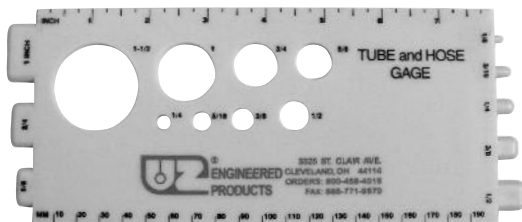

## Electrical Terminal Sizing Gauge #103329



SHOP SUPPLIES

# Tools

## UZ Fix-A-Thread

### EXTERNAL

REPAIRS & RECLAIMS DAMAGED THREADS.  
SAVES TIME, MONEY & INVENTORY COSTS!

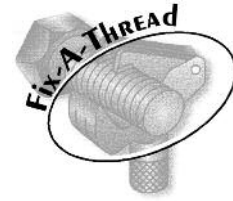

Does the job that used to take 50 or more thread chasing dies to do!

**Metric or Standard Threads  
Right or Left Threads**

- 3 sizes for diameters from 1/4" to 6"
- Repair damaged threads quickly
- Rockwell hardness of 58 RC
- Blades easily adapt to any thread pitch
- Blades automatically fit into the thread grooves eliminating guesswork
- Works on all UNC, UNF, NPT, Metric Threads
- Replacement blades available



#### TOOLS

PART #	DESCRIPTION
91964	5/32" to 11/16" (M4 to M18)
91965	11/16" to 1-1/2" (M17 to M38)
112903	1-1/4" to 6" (M32 to M152)

#### REPLACEMENT BLADES

PART #	DESCRIPTION
91967	Blades pk. 2 for #91964
91968	Blades pk. 2 for #91965
112909	Blades pk. 2 for #112903

Available in an Assortment



#### WHERE CAN FIX-A-THREAD BE USED?

- |                |                |
|----------------|----------------|
| • Maintenance  | • Auto Repair  |
| • Marine       | • HVAC         |
| • Agriculture  | • Trucking     |
| • Plumbing     | • Military     |
| • Truck Repair | • Construction |

- PART # **00963**  
Found on Page 1103
- PART # **00965**  
Found on Page 1103
- PART # **00966**  
Found on Page 1103
- PART # **00967**  
Found on Page 1104

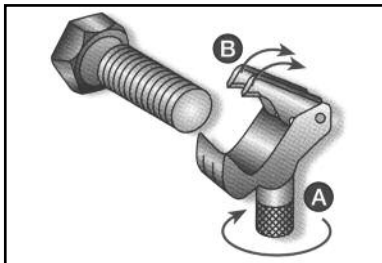

Turn handle (A) to raise floating blades (B). Place the **Fix-A-Thread** tool over thread to be repaired.

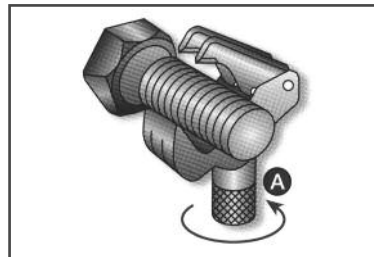

Turn handle (A) to lower floating blades into grooves of thread and tighten by hand only.

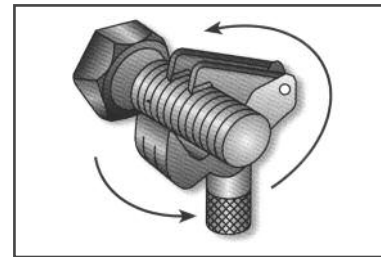

Turn the **Fix-A-Thread** tool in direction of the arrow.

## UZ Fix-A-Thread INTERNAL

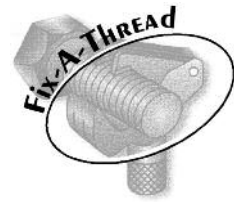

Eliminate the need to re-drill  
and tap by repairing damaged internal threads!

- 5 sizes for diameters from 5/16" to 2-1/8"
- Repair damaged threads quickly.
- Rockwell hardness of 58 RC.
- Blades easily adapt to any thread pitch.
- Blades automatically fit into the thread grooves eliminating guesswork.
- Works on all UNC, UNF, NPT, Metric Threads.
- Replacement blades available.

**Metric or Standard Threads  
Right or Left Threads**

### TOOLS

PART #	DESCRIPTION
112904	5/16" to 7/16" (M8 to M11)
112905	1/2" to 5/8" (M12 to M16)
112906	11/16" to 13/16" (M16 to M20)
112907	7/8" to 1-1/4" (M22 to M32)
112908	1-1/4" to 2-1/8" (M32 to M54)

### REPLACEMENT BLADES

PART #	DESCRIPTION
112910	Blades pk. 1 for #112904
112911	Blades pk. 1 for #112905
112912	Blades pk. 1 for #112906
112913	Blades pk. 1 for #112907
112914	Blades pk. 1 for #112908

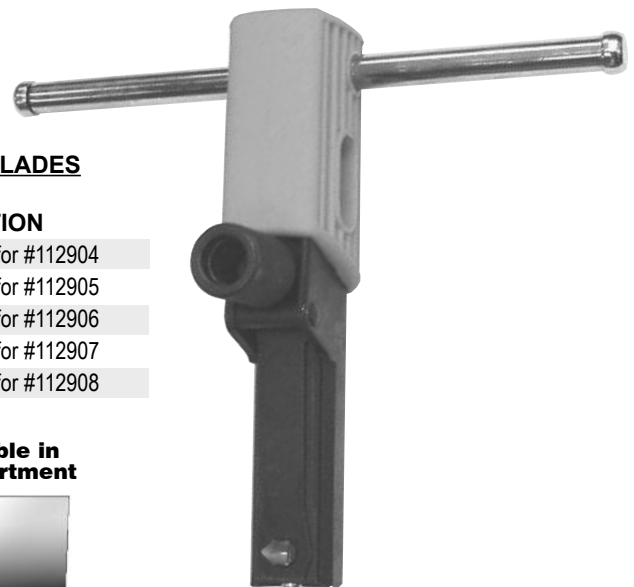

SHOP SUPPLIES

### APPLICATIONS

- |                |                  |
|----------------|------------------|
| • Die Shop     | • Pipe Fitters   |
| • Maintenance  | • Construction   |
| • Automation   | • HVAC           |
| • Millwrights  | • Military       |
| • Truck Repair | • Transportation |

### Available in an Assortment



PART # **00963**  
Found on Page 1103

PART # **00965**  
Found on Page 1103

PART # **00968**  
Found on Page 1104

PART # **00969**  
Found on Page 1104

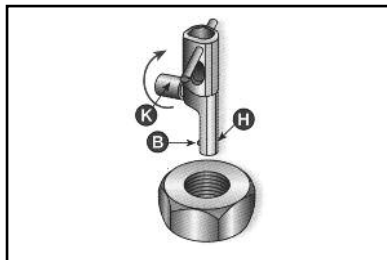

Turn knurled knob (K) to fully retract the blade (B) into the housing (H). Insert **Fix-A-Thread** tool into the threaded hole or bore to be repaired.

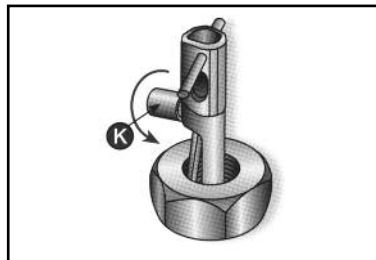

Turn knurled knob (K) to extend blade (B) into a thread groove on an undamaged section and tighten by hand only.

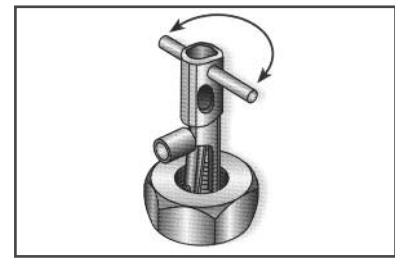

Rotate the **Fix-A-Thread** tool by the cross-rod, as shown, in the desired direction.

# Tools

## Bits-Selector

Dimensions - 4.25" x 2.0" x .075  
Weight - .25 lbs.

10 Assorted bits

- Lightweight, compact, durable, high-impact plastic holder.
- Molded hex cavity turns box into handle for quick fastening jobs.
- Quick bit access with slide out drawer.
- Includes magnetic adapter/extender for power tool use.



PART #	QUANTITY
55018	1

## Caulking Gun

Dispenses all materials found in standard spouted cartridges.

- All steel construction.
- Large, comfortable trigger.
- Blue enamel body.
- Deep serrations on plunger rod for sure, steady application.
- Accepts all standard cartridges.
- Built to last.



PART #	QUANTITY
190950	1

## Gasket, Etc. Caulking Gun

- 100% patented dripless feature
- 18:1 ratio
- Engineered ergonomic construction
- Rotating barrel
- Rugged composite construction
- Reinforced cage for extra strength
- Sharp precision cutter
- Extra long clean out
- Drip/No Drip feature for bead control
- Recommended for use with all caulks, construction adhesives including polyurethanes, concrete masonry and roofing sealants



PART #	DESCRIPTION	QUANTITY
103060	Gasket, ETC. Caulk Gun	1

## Steel Stamp Sets Numerals and Letters

- For making wood, metal, leather and plastic.
- Protects valuables against theft.
- Steel stamps permanently mark and identify tools, keys, household goods, bicycles and other items clearly and permanently.
- High alloy, heat treated steel stamps.
- Thumb grooves to orient figure automatically.
- Number set includes 0-8 (use 6 for 9).
- Letter set includes A through Z and period.



PART #	TYPE	SIZE	QUANTITY
178501	Number	1/8"	1
178503	Number	1/4"	1
178505	Letter	1/8"	1
178507	Letter	1/4"	1

## MEGAPRO 15-in-1 Screwdriver

- Retracting bit cartridge.
- Manufactured with high-grade steel shaft.
- Easy bit storage in the handle.
- Ergonomically designed handle-for greater user comfort and control.
- High impact plastic handle-durability and flexibility for all type of work applications.



Bits store in handle!

PART #	DESCRIPTION
104847	MEGAPRO 15-in-1 Screwdriver

## 4-In-One Screwdriver (Phillips and Slotted)

A durable heavyweight screwdriver made to fit most Slotted and Phillips screws. Comes complete with two double-ended bits: 3/16" Slotted and #1 Phillips, plus 5/16"slotted and #2 Phillips.

- Bits lock into barrel
- Barrel locks into handle
- Bits fit most screws
- Alloy steel bits
- Made in U.S.A.
- Permanent storage

PART #	QUANTITY
178153	1



## Replacement End Bits

PART #	TYPE	QUANTITY
178148	Double End Phillips	1
178149	Double End Slotted	1

## 4-In-One TORX® Screwdriver

TORX® Screwdriver for headlight bezel, turnlight assemblies, mirror mounts, exterior trim, carburetor and ignition systems. Comes complete with two double-ended bits: T-15 and T-20 Torx plus T-25 and T-30 Torx.

PART #	QUANTITY
178154	1



## Flexible Spring Claw

Bright plated steel spring reaches into inaccessible, awkward places. Press the easy-working plunger and four spring steel claws expand. Release the plunger and claws retract, gripping tight and sure. Picks up any material, unplugs clogged drains, reaches behind radiators, file cabinets grasps hot utensils, dropped machine parts, tools, papers.

PART #	OVERALL LENGTH	QUANTITY
178150	13-1/2"	1
178151	23-1/2"	1

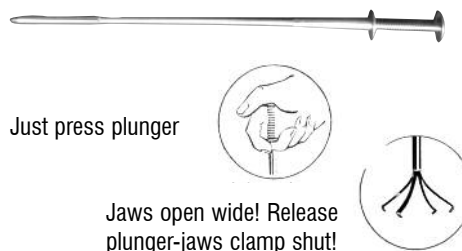

Just press plunger

Jaws open wide! Release plunger-jaws clamp shut!

## 3/8" Drive 20 Pc. Socket Set



PART #	QUANTITY
175219	1 (20 piece set)

SIZE	DESCRIPTION
3/8"	6 Point Regular Socket
7/16"	6 Point Regular Socket
1/2"	6 Point Regular Socket
9/16"	6 Point Regular Socket
5/8"	12 Point Regular Socket
11/16"	12 Point Regular Socket
3/4"	12 Point Regular Socket
13/16"	12 Point Regular Socket
7/8"	12 Point Regular Socket
3/8"	6 Point Deep Socket
7/16"	6 Point Deep Socket
1/2"	6 Point Deep Socket
9/16"	6 Point Deep Socket
5/8"	6 Point Deep Socket
11/16"	6 Point Deep Socket
3/4"	6 Point Deep Socket
13/16"	6 Point Deep Socket
3" Extension	
6" Extension	
Reversible Ratchet	
Blow Molded Box	

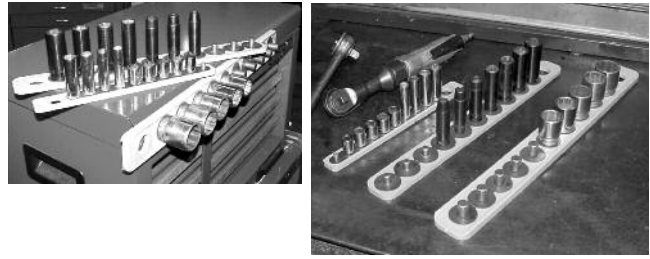

## Magnetic Socket Holder

3 Drive sizes: 1/4", 3/8", and 1/2" to fit standard and metric sockets.

- Easy-on, Easy-off and it replaces difficult clips.
- Will not rust, corrode or chip.
- Will not magnetize sockets.
- Tough polyethylene base.
- Holds tight to metal surfaces.

PART #	DESCRIPTION
105570	1/4" Drive
105571	3/8" Drive
105572	1/2" Drive
105573	Set of all 3 sizes



## Nutdriver Sets

Popular nutdriver sizes are available in 7-piece fractional and metric sets.

- Comfortable ergonomic cushion grip
- Hardened CVM Steel for durability

PART #	TYPE	SET INCLUDES	QUANTITY
178085	Fractional	3/16", 1/4", 5/16", 11/32", 3/8", 7/16", 1/2"	1
178086	Metric	5, 5.5, 6, 7, 8, 10, 13mm	1

## Ultra™ Pivoting Head Ratcheting Screwdriver

The **Ultra™ Pivoting Head Ratcheting Screwdriver** is an extremely versatile 15-in-1 five way ratcheting screwdriver. The screwdriver head pivots and locks in 5 positions; 0°, 45°, 90°, 135° and 180° angles.

The **Ultra Driver™** is actually 3 tools in one: **(1)** a pivoting head ratcheting screwdriver that locks in 5 operating positions, **(2)** a ratchet wrench tool capable of high torque applications, and **(3)** a combination short or long screwdriver shaft for hard to reach applications.

The ratchet mechanism has three working positions; forward, reverse and locked and has a high torque capacity.

The **Ultra™ Pivoting Head Ratchet Screwdriver** comes complete with 13 bits, a 2" (50mm) magnetized shaft extension and a storage rack that fits inside the handle. The transparent handle has been ergonomically designed for comfort and is made from a chemical resistant material. The **Ultra™ Pivoting Head Ratchet Screwdriver** also has a standard 1/4" (6.35mm) locking hex opening to hold all standard driver bits and meets or exceeds all ANSI and DIN standards.

The **Ultra™ Pivoting Head Ratchet Screwdriver** is a must for every toolbox. Those hard to turn or hard to reach screws and bolts are no match for this unique tool.



Part #117507



Head pivots and locks in 5 positions



2" (50mm) shaft extension



12 bits and shaft extension store inside the handle



Angled ratchet screwdriver or socket wrench

SHOP SUPPLIES

## Saw Driver 11-in-1 Saw and Screwdriver Set

### Features:

- The handle can be used straight or adjusted to a 60° angle for increased torque
- Interchangeable saw blades and screwdriver shaft
- Saw blades and screwdriver shaft lock in place
- Standard size saw blades

### 11 piece set contains:

- 1 Adjustable angle handle
- 7 Screwdriver bits
- 1 Magnetic screwdriver shaft and bit holder
- 1 Saw blade for wood
- 1 Saw blade for metal

The Saw Driver 11-in-1 Saw and Screwdriver Set is a very versatile tool that will come in handy around the shop, garden, garage or just about anywhere a saw or screwdriver is needed.

The Saw Driver 11-in-1 Saw and Screwdriver Set is a must for every tool box.



A great tool for the shop, garden or garage. Anywhere a saw or a screwdriver is needed.

60°

Part #118871



6 bits store inside the screw-on cap



Screwdriver



60° angle grip for more torque



## RotoMag Magnetic Pick-up Tool RMX7

### Metal chip clean up

This powerful rare earth magnet is the fastest and safest way to clean metal chips from a work area. Instead of using a cloth to clean a workbench or desk, simply wave the RotoMag RMX7 over the area to be cleaned and watch it pick up metal shavings with ease.

### Small metal pieces pick up

You can also pick up small fasteners (magnetic) to move them or retrieve them from hard to reach areas.

PART #	LENGTH	DIAMETER	WEIGHT
107136	15 3/4	1"	17 oz.



## Pocket Telescopic Magnetic Pick-Up Tool

The perfect new magnetic pick-up tool you can carry with you on every job! Sized to clip into your pocket easily. Yet when telescoped out can reach through grills, grates, behind wires, pipes and panels where hands can't reach.

Powerful enough to pick up dropped nuts, bolts, tools and other ferrous parts.

- Extends out to 18-1/8"
- Handy pocket clip
- Closes down to convenient 5-1/2" pocket size.
- Bright chrome plated shaft.
- Super telescoping action.
- Strong long-life magnet.

PART #	QUANTITY
178152	1



## Mechanical Screw Starters

### For ferrous or non-ferrous screws

No more fumbling with hard-to-position screws! A simple twist of the alloy steel bit and screw is firmly held, ready for trouble-free starting. Tool releases and resets automatically. Slender aluminum handles allow for easy access into close areas.

Should a screw, washer or nut be dropped into a hard-to-reach area, it can easily be retrieved by turning the tool around and using the strong magnet on the opposite end of the aluminum handle screw starter.



PART #	DESCRIPTION	QUANTITY
178158	W/ Pocket Clip 5-3/4" Long Overall	1



PART #	DESCRIPTION	QUANTITY
178157	W/ Pocket Clip 5-5/8" Long Overall	1

## Nut Starter

Use on small size nuts to start nuts on bolt thread. Releases from nut as threads are engaged.

Overall length 5-1/8"

Std. Pkg. 1 doz.

Pkg. wt. 1lb. 1 oz.

- Snap-in-nut.
- Start threads.
- Self-releasing.

FITS SIZES:

4-40 Thread                      5/16"  
3/32"                                  to                      8mm  
2.5mm

PART #	QUANTITY
178156	1

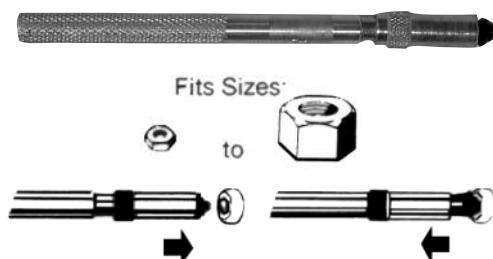

## Magnetizer/ Demagnetizer

Magnetizes and demagnetizes screwdrivers and other small tools. Works in seconds - simple to use. Speeds up repair and assembly jobs. Picks up screws, nuts, metallic parts, cleans up filling, scraps, and start screws.

PART #	OVERALL SIZE	QUANTITY
178155	1-1/16" x 1-1/16" x 1-1/16"	1

To Magnetize:

Put end of tool into magnetizer hole several time.

Remove magnetizer and tool will remain magnetized.

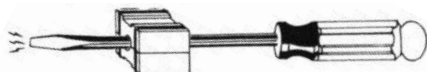

To Demagnetize:

Pull tool through grooved side of magnetizer to make sure demagnetization is complete.

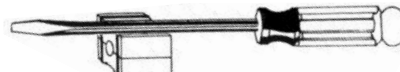

# Tools

## Power

### 1/4" Hex Phillips Power Bits 2" Long



PART #	SIZE	QUANTITY
178163	1	2
178164	2	2
178165	3	2

### 1/4" Hex Slotted Power Bits 2" Long



PART #	BLADE WIDTH	QUANTITY
178176	3/16"	2
178177	1/4"	2
178178	9/32"	2
178179	5/16"	2
178180	3/8"	2

### Power Magnetic Bit Holder 3"



PART # 178181 (Accepts all 1/4" bits)

### 1/4" Hex Square Drive Power Bits



PART #	SIZE	QUANTITY
107090	0 X 2"	5
107091	1 X 2"	5
107095	2 X 2"	5
107099	3 X 2"	5
107092	1 X 3"	5
107096	2 X 3"	5
107100	3 X 3"	5
107093	1 X 4"	5
107097	2 X 4"	5
107101	3 X 4"	5
107094	1 X 6"	5
107098	2 X 6"	5
107102	3 X 6"	5

## Insert

### 1/4" Hex Phillips Insert Bits 1" Long



PART #	SIZE	QUANTITY
178159	0	2
178160	1	2
178161	2	2
178162	3	2

### 1/4" Hex Slotted Insert Bits 1" Long



PART #	BLADE WIDTH	QUANTITY
178170	3/16"	2
178171	7/32"	2
178172	1/4"	2
178173	9/32"	2
178174	5/16"	2
178175	23/64"	2

### 1/4" Hex TORX Insert Bits 1" Long



PART #	SIZE	QUANTITY
178182	T10	2
178183	T15	2
178184	T20	2
90000	T25	1
178186	T27	2
90001	T30	1
90002	T40	1

Available in  
an Assortment



PART # 103143  
PART # 103143KP  
PART # 118587KP  
Found on Page 1105

## 1/4" Square Drive Insert Bits 1" Long

PART #	SIZE	QUANTITY
107085	0	5
107086	1	5
107087	2	5
107088	3	5
107089	4	1



## 1/4" Shank Magnetic Hex Drivers

PART #	SIZE	QUANTITY
90516	1/4" x 1-3/4"	1
90517	5/16" x 1-3/4"	1
90518	3/8" x 1-3/4"	1



## TORX Bit Holder

PART #	QUANTITY
90003	1



## 32 PC. Industrial Driver Bit Set

- S2 Modified Tool Steel for Durability
- Hardened to RC 58-61 for Toughness
- Precision Machined for Non-slip Grip
- Packaged in a Handy, Portable Plastic Case with a Belt Clip

### Driver Bit Contents:

Phillips	0, 1, 2, 2R, 3
Torx®	10, 15, 20, 25, 27, 30, 40
Slotted	3-4, 4-5, 6-8, 8-10, 10-12
Hex	5/64, 3/32, 7/64, 1/8, 9/64, 5/32, 3/16, 7/32, 1/4, 5/16
Square	1, 2, 3

Plus a Quick Release Bit holder and 1/4 x 1/4 Socket

PART #	DESCRIPTION	QUANTITY
123503	Industrial Driver Bit	1



Part #123503

## 32 PC. Industrial Security Bit Set

- S2 Modified Tool Steel for Durability
- Hardened to RC 58-61 for Toughness
- Precision Machined for Non-slip Grip
- Packaged in a Handy, Portable Plastic Case with a Belt Clip

### Security Bit Contents:

Phillips Security	2, 3
Torx® Security	5, 6, 7, 8, 9, 10, 15, 20, 25, 27, 30, 40
Hex Security	5/64, 3/32, 7/64, 1/8, 9/64, 5/32, 3/16, 7/32, 1/4, 5/16
Spanner Security	4, 6, 8, 10, 12, 14

Plus a Quick Release Bit holder and 1/4 x 1/4 Socket

PART #	DESCRIPTION	QUANTITY
123504	Industrial Security Bit	1



Part #123504

# Tools

## Pliers

- Drop forged.
- Comfortable vinyl grips.
- Quantity 1
- Induction hardened cutting edges.
- Brightly polished surfaces.

### Slip Joint Pliers

PART #	SIZE
177950	8"

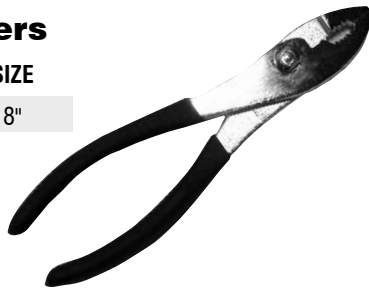

### Linesman Pliers

PART #	SIZE
177951	7"



### Diagonal Pliers

PART #	SIZE
177953	7"



### Needle Nose

PART #	SIZE
177954	5"



### Long-Nose Pliers

PART #	SIZE
177952	6-1/2"



### Cushion Grip "Rib-Joint" Utility Pliers

Teeth designed to give a maximum grip to any object. The jaws are positively locked in position by the rib and groove-joint design, and cannot slip under any pressure. This plier is ideal for automotive work and general utility service.

PART #	SIZE
175211	10"
175212	12"
175213	16"



### Aviation Tin Pliers

Standard with cushion handles.  
Length 10".  
Color coded: yellow/cuts straight.

PART # 175214
---------------



## Adjustable Wrenches

- Drop forged.
- Heat treated & tempered.
- Alloy steel.
- Chrome plated.
- Brightly polished.
- Industrial quality.

PART #	SIZE	QUANTITY
177955	6"	1
177956	8"	1
177957	10"	1
177958	12"	1

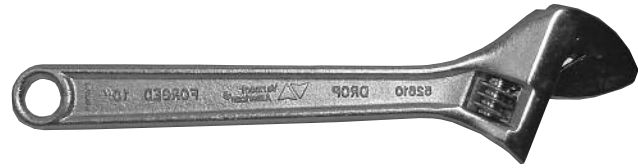

## Multi-Wrench

### 8-in1 SAE Wrench

- Chrome Vanadium Hardened Steel-with a solid shaft stands up to heavy use.
- Chrome plated to resist rust.
- Replaces-5/16", 3/8", 9/16", 5/8", 7/16", 1/2", 11/16", and 3/4" SAE sizes.

PART #	DESCRIPTION
105197	Multi-Wrench



## Thread Restorers

Renews damaged threads of any diameter bolt, screw, stud, etc. For right or left hand threads.

PART #	DESCRIPTION	QUANTITY
177999	Threads per inch: 11, 12, 13, 14, 16, 18, 20, 24	1
178000	threads per inch: 9, 10, 12, 16, 20, 27, 28, 32	1



## Autoload Utility Knife

### Features

- Autoloading design- No tools needed
- One button blade change
- Ergonomic rubber grip
- Heavy duty die cast body
- Holds any standard utility blade
- 5 blades included



Push button to remove blade



Push slider back to load blade



Push slider forward to use new blade

PART #	DESCRIPTION	QUANTITY
116007	AUTO LOAD UTILITY KNIFE	1
116015	SPARE BLADES FOR UTILITY KNIFE	10

## Scrapermate

- Blade holder tilts the blade to give better angle of attack in tight corners.
- Ideal for removing paper stickers and dried paint.
- Retractable: Blade can be folded 180 degrees into handle and locked permitting safe tool storage.
- Blade easy replaced - PART # 10319.
- 7-7/8" overall length.



PART #	QUANTITY
177944	1

## Razor Scraper

- Retractable for safety when not in use.
- A must for all razor blade applicators.
- Use with #10319 blades.
- 4" overall length.



PART #	QUANTITY
10320	1

## Industrial Razor Blades Single Edge

- Ideal for carton cutting.
- Scrapes paint and paper with ease.
- Individually wrapped for safety.
- Packed 100 blades in plastic tubing.



PART #	QUANTITY
10319	1 Box (100 ea.)

## Industrial Hammers

### Claw Hammer - Fiberglass Handle

- Weight: 16oz.
- Overall Length: 13-1/8".

PART # QUANTITY

178520 1



### Ball Pein Hammer - Fiberglass Handle

All Pk. Qty. 1

PART #	HEAD WEIGHT	OVERALL LENGTH	WEIGHT (lb)
178521	4 oz.	10-3/4"	.35
178522	8 oz.	11"	.65
178523	12 oz.	13"	1.08
178524	16 oz.	13-1/4"	1.34
178525	24 oz.	14"	1.80
178526	32 oz.	14"	2.40



### Soft Bronze Hammer - Wooden Handle

- Weight: 1.18 lbs.
- Overall Length: 12".

PART # QUANTITY

178527 1



### Cross Pein -Fiberglass Handle

- Head Weight: 3lb.
- Weight: 3.4 lb.
- Overall Length: 15".

PART # QUANTITY

178528 1



### Soft Face Hammer - Fiberglass Handle

Tough, replaceable type - protect work from impact damage.

PART #	OVERALL LENGTH	WEIGHT (lb)	QUANTITY
178531	12-1/4"	.75	1
178532	12-1/4"	1.00	1

#103033 Pk 2 Replacement Tips



# Brushes

## Bent Handle Scratch Brush

- All-purpose brush for cleaning structural steel, iron works & castings.
- Durable wire bristles.
- For all types of dirt and dust removal.
- Bent handle for easier, more comfortable use.
- 6" of bristles, 4 rows wide.
- Overall length 14".

PART #	BLOCK WIDTH	TRIM LENGTH	QUANTITY
10969	1-1/8"	1-3/16"	1



## Shoe Handle Scratch Brush

- For general purpose rust, scale, and dirt removal.
- Popular for cleaning pipe threads, welds, etc.
- Overall length 10".

PART #	BLOCK WIDTH	TRIM LENGTH	QUANTITY
200491	1-1/8"	1"	1



## Stainless Steel Scratch Brush

- 302 stainless steel wire bristles.
- For cleaning stainless steel.
- 6" of bristles, 4 rows wide.
- Overall length 14".

PART #	BLOCK WIDTH	TRIM LENGTH	QUANTITY
10970	1-1/8"	1-3/16"	1



## Stainless Steel Shoe Handle Scratch Brush

- 302 stainless wire bristles.
- Overall length 10".

PART #	BLOCK WIDTH	TRIM LENGTH	QUANTITY
200438	1-1/8"	1-3/16"	1



## Stainless Steel Miniature Scratch Brush

- For hard-to-reach areas.
- Overall length 7-7/8".

PART #	BLOCK WIDTH	TRIM LENGTH	QUANTITY
91606	1/2"	1/2"	3



## Parts Cleaning Brushes

- Durable Prostran bristles.
- Dome trim and square trim available.
- Ideal for cleaning engine parts around motors.
- Comfortable lacquered wooded handle.
- Overall length 11".

PART #	BLOCK WIDTH	TRIM LENGTH	TRIM STYLE	QUANTITY
10857	15/16"	2-3/4"	Dome	1
200495	15/16"	2-3/4"	Square	1



## Polyester Paint Brushes

- Plastic handle.
- Polyester bristles retain stiffness.
- For use with latex or oil based coatings.
- A general purpose "all in one" paint brush.
- Pack QTY. 12.

PART #	BLOCK WIDTH	TRIM LENGTH	THICKNESS
10848	1"	1-3/4"	5/16"
10849	2"	1-3/4"	5/16"
10851	3"	1-3/4"	3/8"



## Disposable Chip Brushes

- Unpainted wooden handle can't chip or melt.
- 100% pure bristles.
- For general purpose use, chip cleaning, and cutting oil application.

PART #	BLOCK WIDTH	TRIM LENGTH	THICKNESS	QUANTITY
200483	1/2"	1-5/8"	5/16"	6
10853	1"	1-5/8"	5/16"	12
10854	2"	1-5/8"	5/16"	12
200487	3"	1-7/8"	3/8"	3
200488	4"	1-7/8"	3/8"	3



Available in an Assortment



PART # 00438  
Found on Page 1101

## Acid Brush

- For applying acid solder.
- Horse hair fill.
- Tin ferrule.
- Pack Qty 24.

PART #	TRIM DIAMETER	FERRULE LENGTH	FACE DIAMETER	WIDTH
10855	5/16"	3/4"	5/16"	1/2"



# Brushes

## Fender Brushes

- A tough palmyra bristle brush with one-piece solid block.
- For general purpose cleaning applications

PART #	BLOCK SIZE	OVERALL LENGTH	QUANTITY
200492	4-1/2" x 6"	10"	1
200493	4-1/2" x 6"	21"	1



## Window and Vehicle Washing Brush

- A blend of horse hair and nylon bristles
- Block size 8" x 2-1/2"
- 2-1/2" trim
- For use in washing windows, trucks, buses, cars, etc.
- Keeps its shape and stays soft even after repeated exposure to water, detergents etc.

4-1/2 foot wood handle for #200498 brush must be ordered separately

PART #	DESCRIPTION	QUANTITY
200498	Brush	1
200499	Handle	1



Shipped without handle



## Whisk Brush

- Stiff palmetto fibre bristles
- Wire Handle
- Long Lasting
- Overall length 7-1/2"
- Face width 3-1/2"

PART #	QUANTITY
200497	1



## Counter Duster

- A combination of stiff center bristles and soft border bristles.
- A good general purpose duster for medium to heavy duty applications.
- Overall length 12-1/4"
- Trim length 2-1/2"

PART #	QUANTITY
200489	1

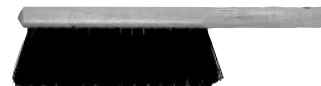

## Floor Brush

- For medium applications, indoors or outdoors.
- Black plastic with horse hair mix casing.
- Crimped black plastic center loosens stubborn dirt.
- Horse hair and plastic casing removes fine dust.
- Not shipped with handle.

PART #	BLOCK WIDTH	TRIM LENGTH	QUANTITY
10967	24"	2-7/8"	1

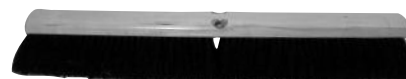

## Garage Brush

- For heavy duty applications.
- Ideal for wet to dry conditions.
- Perfect for factory and garage floors.
- Resistant to oil, water, and most chemicals.
- 100% crimped plastic construction.
- Not shipped with handle.

PART #	BLOCK WIDTH	TRIM LENGTH	QUANTITY
10966	24"	3-3/16"	1



## Wooden Handle

- For use with Floor Brush #10967 and Garage Brush #10966.
- Metal threads.
- Lacquered finish.
- 5 foot length
- 15/16" diameter

PART #	QUANTITY
10965	1



## The Brush...Indestructible!

- Outlasts conventional floor brushes 10 to 1.
- Choice of solvent resistant bristles to meet every sweeping situation.
- Lightweight and rugged construction pleases the most discriminating user.
- 5-Year Guarantee.



All brushes are shipped without handles. Order handles separately.

### BRUSH SELECTION GUIDE:

**BLUE:** The tips of these solvent resistant bristles are "flagged" or exploded to give each individual bristle hundreds of tiny filaments. This makes this brush your best choice for very smooth floors like smooth concrete, vinyl tile, gymnasiums, and other smooth floors.

**BLACK:** A blend of stiff and soft bristles ideal for average, all around sweeping. For use on machine shop floors, docks, in-plant offices, etc. This is a rugged brush that holds up well under dry, wet, or oily conditions.

**BROWN:** Very stiff bristles makes this brush ideal for sweeping very rough surfaces under adverse wet, dry, oily, or greasy conditions. Excellent for scrubbing large areas and sweeping extra-heavy refuse, and even removing a light snow from sidewalks and stairs, etc.

PART #	DESCRIPTION	QUANTITY
200461	17" Blue Brush	1
200462	23" Blue Brush	1
200463	29" Blue Brush	1
200464	35" Blue Brush	1
200466	23" Black Brush	1
200467	29" Black Brush	1
200468	35" Black Brush	1
200469	17" Brown Brush	1
200470	23" Brown Brush	1
200471	29" Brown Brush	1
200472	35" Brown Brush	1
200473	60" Miracle Tip Steel Handle (Fits all brushes & squeegees)	1

## Miracle Tip Handle

A heavy-duty steel handle 60" long with steel connector permanently attached. Fits all brushes and squeegees.



### GUARANTEE:

**The Brush** is guaranteed for 5 years against defects in material, workmanship, or breakage in use. The **Miracle Tip Handle** is guaranteed for 1 year from defects in material, workmanship or breakage within 8" of metal connector while in use. Exclusions: abuse or neglect.

# Squeegees/Oilers

## Squeegees

- Special composition blade for long lasting use.
- Rigid plastic backing for greater support.
- Blade and backing will not separate.
- Use with the Miracle Tip Handle # 200473 and Holder # 200478 (order separately).

Handle not included order separately.



(WIDTH)  
SIZE

18"

24"

30"

36"

Order **Handle** # 200473 and **Holder** # 200478 separately.

PART #	DESCRIPTION	QUANTITY
200474	18" Squeegee Blade only	1
200475	24" Squeegee Blade only	1
200476	30" Squeegee Blade only	1
200477	36" Squeegee Blade only	1
200478	Squeegee Holder (Order separately)	1
200473	60" Miracle Tip handle (Order separately)	1



**PART # 200478** Squeegee holder

This bracket must be used to attach squeegee to handle. Order separately.

## Quality Oilers

**UZ makes it easier to keep things running smoothly!**



PART # 10887



PART #10888



PART # 10889



PART # 200520



PART # 200521

PART #	DESCRIPTION	CAPACITY	QUANTITY
10887	Painted, pistol type 5" rigid spout	6 oz.	1
10889	Painted, pistol type 6" flex spout	6 oz.	1
10888	Painted, pistol type 7" rigid spout	1 pt.	1
200520	Painted, handle type 8" flex spout	14 oz.	1
200521	Painted, handle type 8" rigid spout	14 oz.	1